



NOAH BIKE RACK

Design: HJØRRING KOMMUNE

Modular, so can be assembled in the length required

Available vertical (90°) or angled (45°)

Available as column with 16 parking spots



HITSA A/S
Albuen 37
DK 6000 Kolding
+45 75 57 41 55
hitsa@hitsa.com
www.hitsa.com

HITSA
WE SUPPLY OUTDOOR SPACES

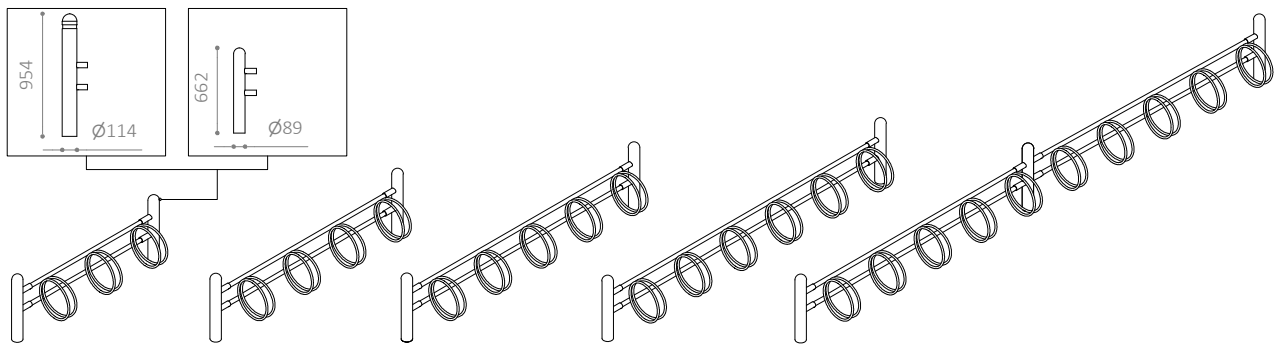

NOAH 500

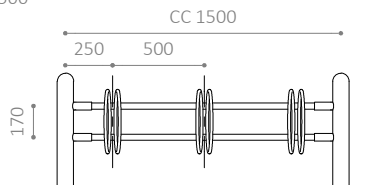

NOAH 500

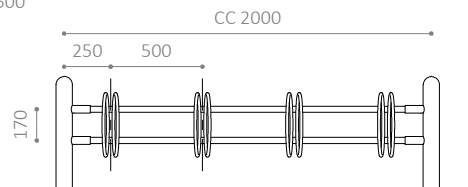

NOAH 500

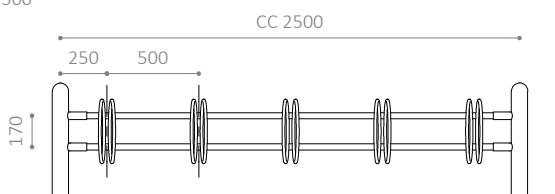

NOAH 500

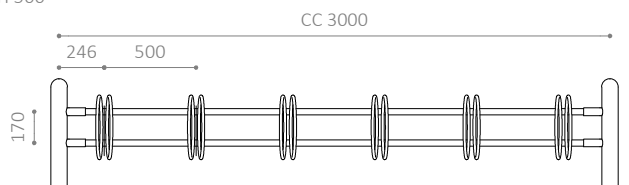

NOAH BIKE RACK

- Angled clamps that suit all types of tyre
- Modular, so can be assembled in the length required
- Available vertical (90°) or angled (45°)
- Also available as an individual stand (Snap)
- Optional extra: TRIANGEL or LOCKT lockable bracket
- Also available in any RAL colour

MATERIALS:

- Hot-dip galvanised steel
- Also available in powder-coated, hot-dip galvanised steel

DIMENSIONS:

Columns without groove: $\varnothing 89$ mm
 Columns with groove: $\varnothing 114$ mm
 Columns, Snap: $\varnothing 42$ mm

Bars: $\varnothing 33$ mm

Clamps: $\varnothing 16$ mm

Standard distance between clamps: c/c 500 mm

Also available: c/c 600 mm

MODULE SIZES:

- Single-sided: 3, 4, 5 or 6 parking spots
- Double-sided: 6, 8 or 10 parking spots

INSTALLATION:

- Available for embedding or bolting to the foundation or wall mounting
- Recommended base dimensions: $\varnothing 300$ x H600 mm
- Distance from ground to middle of clamp: 350 mm
- Distance from ground to lower edge of clamp: 175 mm

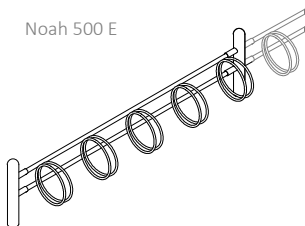

Noah 500 E

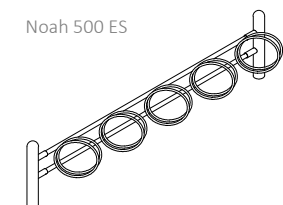
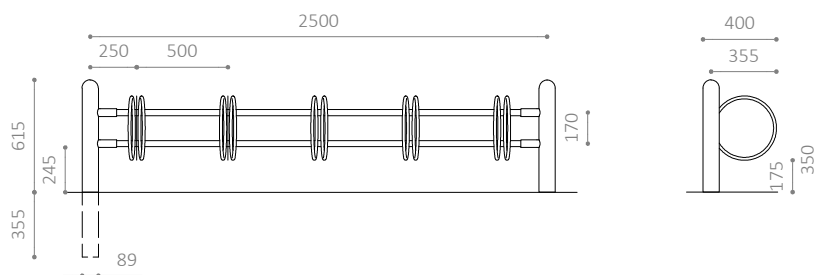

Noah 500 ES

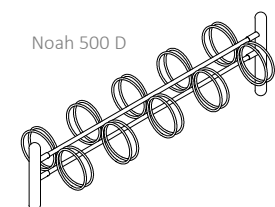
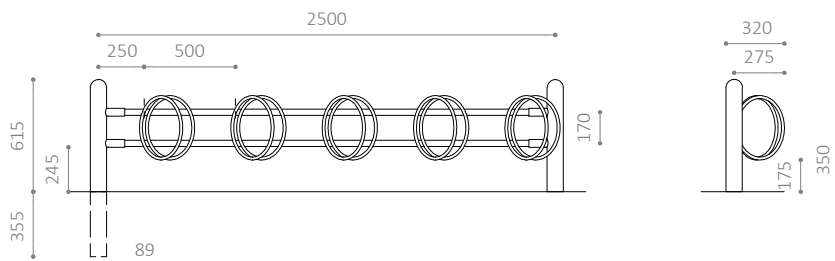

Noah 500 D

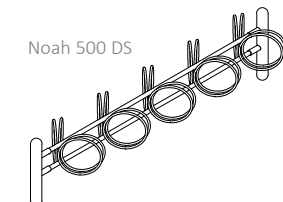
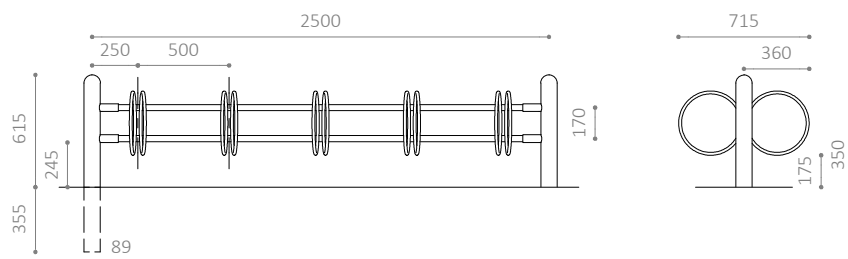

Noah 500 DS

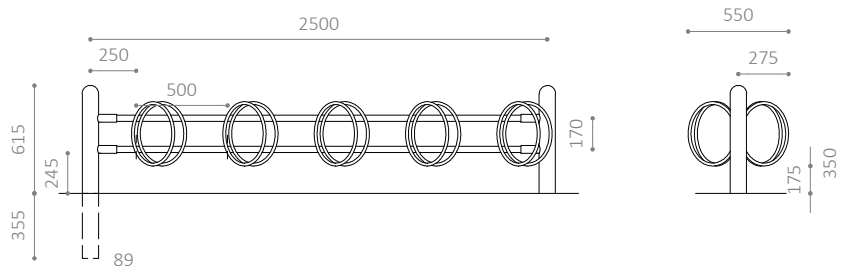

NOAH BIKE RACK

- Angled clamps that suit all types of tyre
- Modular, so can be assembled in the length required
- Available vertical (90°) or angled (45°)
- Also available as an individual stand (Snap)
- Optional extra: TRIANGEL or LOCKT lockable bracket
- Also available in any RAL colour

MATERIALS:

- Hot-dip galvanised steel
- Also available in powder-coated, hot-dip galvanised steel

DIMENSIONS:

Columns without groove: $\varnothing 89$ mm
 Columns with groove: $\varnothing 114$ mm
 Columns, Snap: $\varnothing 42$ mm

Bars: $\varnothing 33$ mm

Clamps: $\varnothing 16$ mm

Standard distance between clamps: c/c 500 mm

Also available: c/c 600 mm

MODULE SIZES:

- Single-sided: 3, 4, 5 or 6 parking spots
- Double-sided: 6, 8 or 10 parking spots

INSTALLATION:

- Available for embedding or bolting to the foundation or wall mounting
- Recommended base dimensions: $\varnothing 300$ x H600 mm
- Distance from ground to middle of clamp: 350 mm
- Distance from ground to lower edge of clamp: 175 mm

Noah 500 V

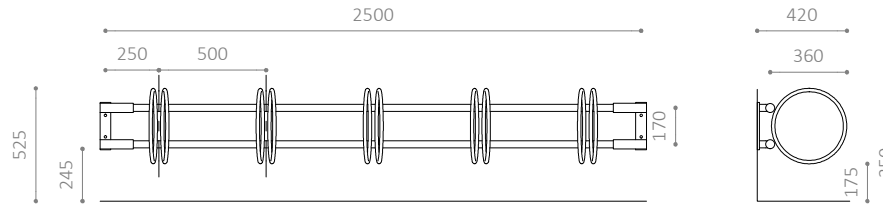
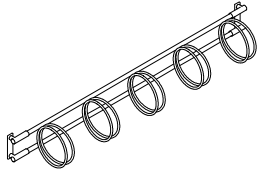

Noah 500 VS

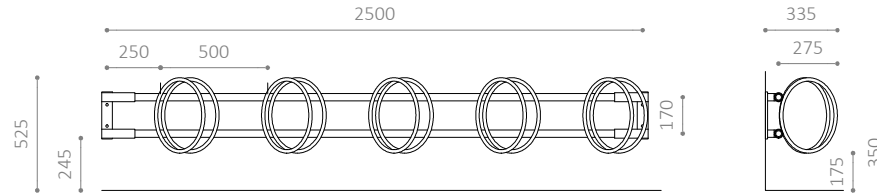
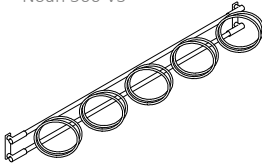

Noah VE

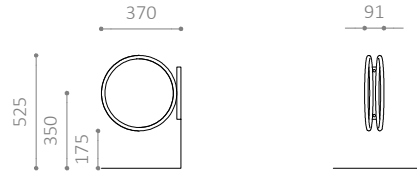

Noah VES

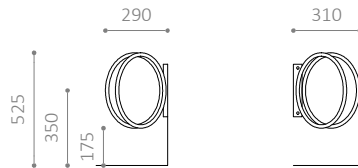

NOAH BIKE RACK

- Angled clamps that suit all types of tyre
- Modular, so can be assembled in the length required
- Available vertical (90°) or angled (45°)
- Also available as an individual stand (Snap)
- Optional extra: TRIANGEL or LOCKT lockable bracket
- Also available in any RAL colour

MATERIALS:

- Hot-dip galvanised steel
- Also available in powder-coated, hot-dip galvanised steel

DIMENSIONS:

Columns without groove: Ø89 mm
 Columns with groove: Ø114 mm
 Columns, Snap: Ø42 mm

Bars: Ø33 mm

Clamps: Ø16 mm

Standard distance between clamps: c/c 500 mm

Also available: c/c 600 mm

MODULE SIZES:

- Single-sided: 3, 4, 5 or 6 parking spots
- Double-sided: 6, 8 or 10 parking spots

INSTALLATION:

- Available for embedding or bolting to the foundation or wall mounting
- Recommended base dimensions: Ø300 x H600 mm
- Distance from ground to middle of clamp: 350 mm
- Distance from ground to lower edge of clamp: 175 mm

Noah SnapE

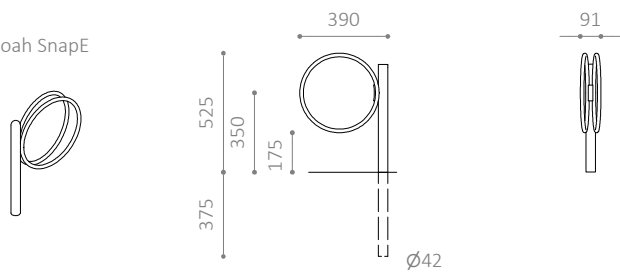

Noah SnapD

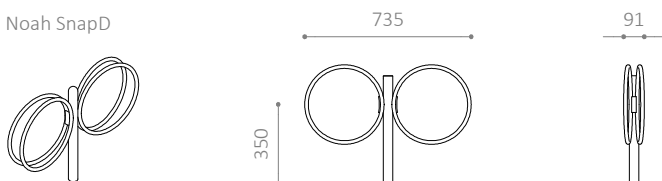

Noah R16

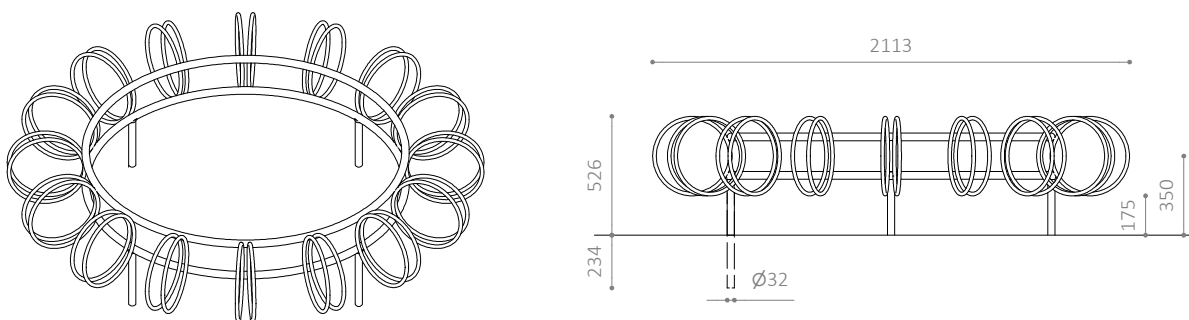

NOAH BIKE RACK

- Angled clamps that suit all types of tyre
- Modular, so can be assembled in the length required
- Available vertical (90°) or angled (45°)
- Also available as an individual stand (Snap)
- Optional extra: TRIANGEL or LOCKT lockable bracket
- Also available in any RAL colour

MATERIALS:

- Hot-dip galvanised steel
- Also available in powder-coated, hot-dip galvanised steel

DIMENSIONS:

Columns without groove: Ø89 mm
 Columns with groove: Ø114 mm
 Columns, Snap: Ø42 mm

Bars: Ø33 mm

Clamps: Ø16 mm

Standard distance between clamps: c/c 500 mm

Also available: c/c 600 mm

MODULE SIZES:

- Single-sided: 3, 4, 5 or 6 parking spots
- Double-sided: 6, 8 or 10 parking spots

INSTALLATION:

- Available for embedding or bolting to the foundation or wall mounting
- Recommended base dimensions: Ø300 x H600 mm
- Distance from ground to middle of clamp: 350 mm
- Distance from ground to lower edge of clamp: 175 mm