



G TYPE BIKE RACK

Design: GINMAN, HARBOE, BORUP LANDSKABSARKITEKTER

Single or double-sided bike rack

Available vertical (90°) or angled (45°)

Rack with 5 spaces single-sided / 10 spaces double-sided

Also available as an individual stand (Snap and wall)

G Type E

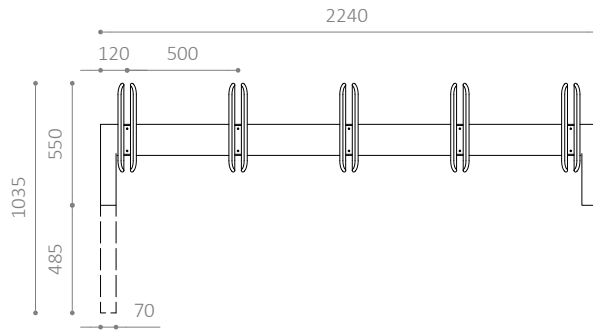
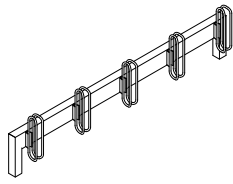

G Type D

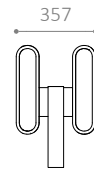
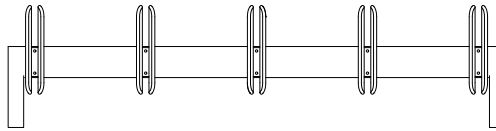
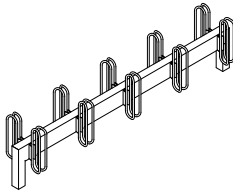

G Type ES

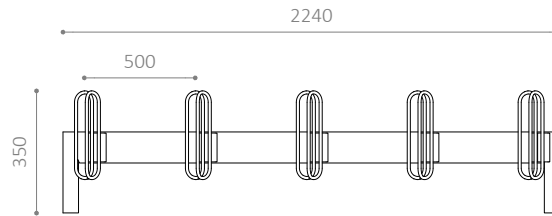
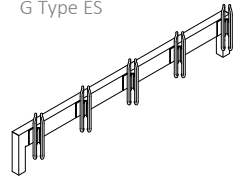

G Type DS

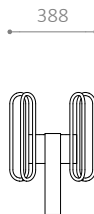
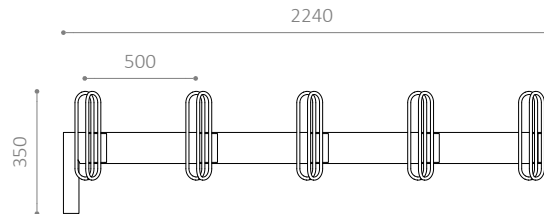
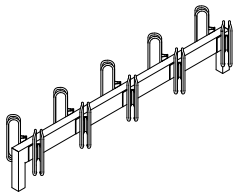

G TYPE BIKE RACK

- Single or double-sided bike rack
- Angled clamps that suit all types of tyre
- Allows room for lights on front wheel fork
- Available vertical (90°) or angled (45°)
- Rack with 5 spaces single-sided
- Rack with 10 spaces double-sided
- Also available as an individual stand (Snap and wall)
- Also available in any RAL colour

MATERIALS:

- Hot-dip galvanised steel
- Also available in powder-coated, hot-dip galvanised steel

DIMENSIONS:

- Columns: 70 x 70 mm
- Bars: 70 x 140 mm
- Clamps: Ø14 mm
- Standard distance between clamps: c/c 500 mm

SNAP version:

- Columns: Ø42 mm (for embedding)

INSTALLATION:

- Available for embedding, bolting to the foundation or as a single rack for wall mounting
- Recommended base dimensions: Ø300 x H600 mm
- Distance from ground to middle of clamp: 350 mm
- Distance from ground to lower edge of clamp: 150 mm

G Type Snap E

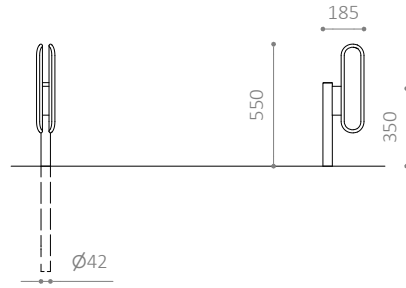

G Type Snap D



G Type EV



G TYPE BIKE RACK

- Single or double-sided bike rack
- Angled clamps that suit all types of tyre
- Allows room for lights on front wheel fork
- Available vertical (90°) or angled (45°)
- Rack with 5 spaces single-sided
- Rack with 10 spaces double-sided
- Also available as an individual stand (Snap and wall)
- Also available in any RAL colour

MATERIALS:

- Hot-dip galvanised steel
- Also available in powder-coated, hot-dip galvanised steel

DIMENSIONS:

Columns: 70 x 70 mm

Bars: 70 x 140 mm

Clamps: Ø14 mm

Standard distance between clamps: c/c 500 mm

SNAP version:

Columns: Ø42 mm (for embedding)

INSTALLATION:

- Available for embedding, bolting to the foundation or as a single rack for wall mounting
- Recommended base dimensions: Ø300 x H600 mm
- Distance from ground to middle of clamp: 350 mm
- Distance from ground to lower edge of clamp: 150 mm