



## DIAN CC600 BIKE RACK

Design: DESIGNIT A/S

Bike rack with extra distance between clamps (c/c 600mm)  
Modular, so can be assembled in the length required  
Available vertical (90°) or angled (45°)



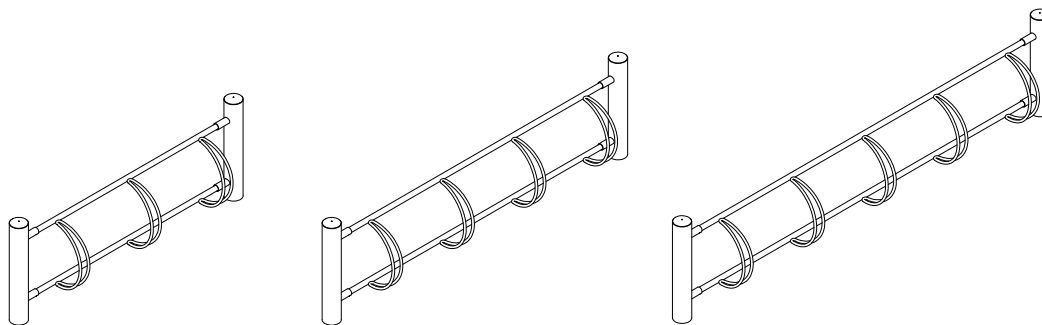

DIAN 600

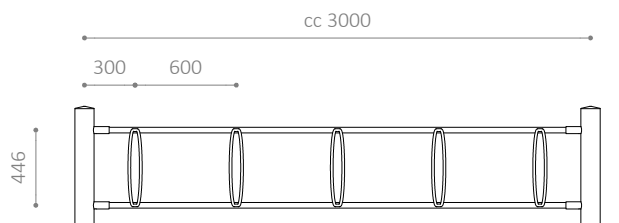

DIAN 600

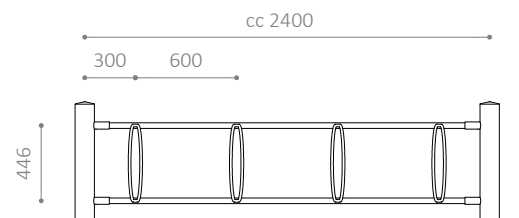

DIAN 600

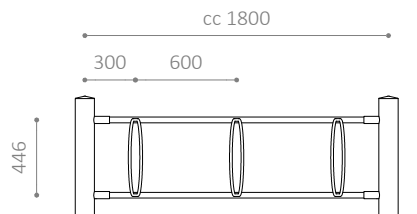

## DIAN CC600 BIKE RACK

- Bike rack with extra distance between clamps (c/c 600mm)
- Angled clamps that suit all types of tyre
- Allows room for lights on front wheel fork
- Modular, so can be assembled in the length required
- Single- or double-sided
- Available vertical (90°) or angled (45°)
- Also available as an individual stand (Snap or wall)
- Also available in any RAL colour

## MATERIALS:

- Hot-dip galvanised steel
- Also available in powder-coated, hot-dip galvanised steel

## DIMENSIONS:

- Columns, DIAN: Ø114 mm
- Columns, Snap: Ø42 mm
- Bars: Ø33 mm
- Clamps: Ø16 mm
- Distance between clamps: c/c 600 mm (also available: c/c 500 mm)

## MODULE SIZES:

- Single-sided: 3, 4, 5 or 6 parking spots
- Double-sided: 6, 8 or 10 parking spots

## INSTALLATION:

- Available for embedding or bolting to the foundation or wall mounting
- Recommended base dimensions: Ø300 x H:600 mm
- Distance from ground to middle of clamp: 250 mm
- Distance from ground to lower edge of clamp: 110 mm

DIAN 600 E

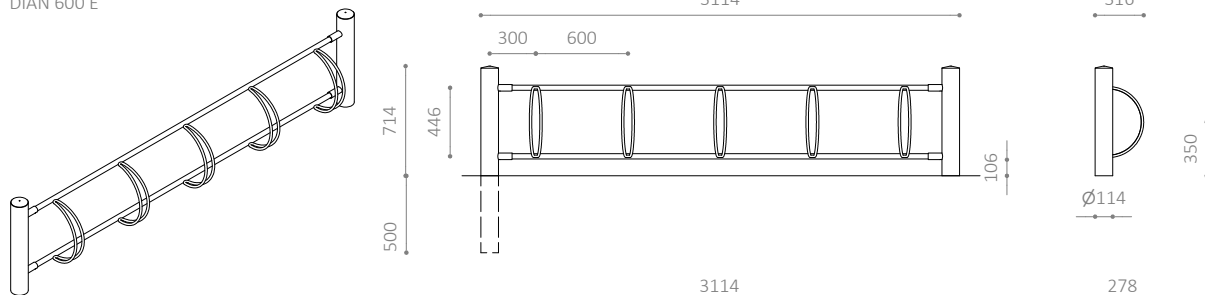

DIAN 600 ES

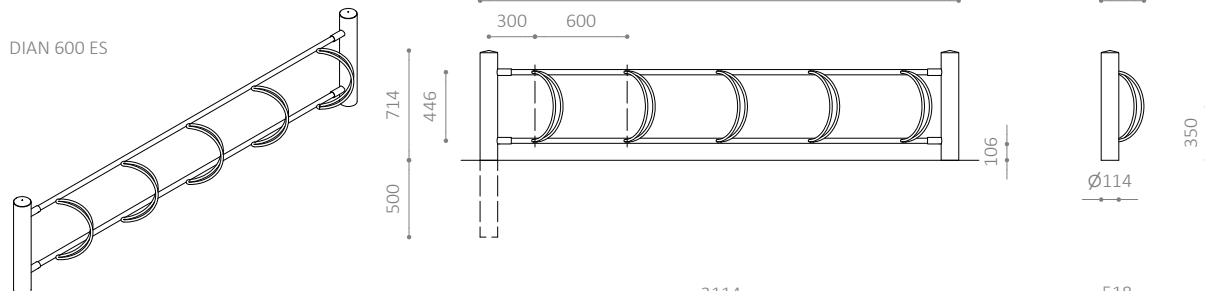

DIAN 600 D

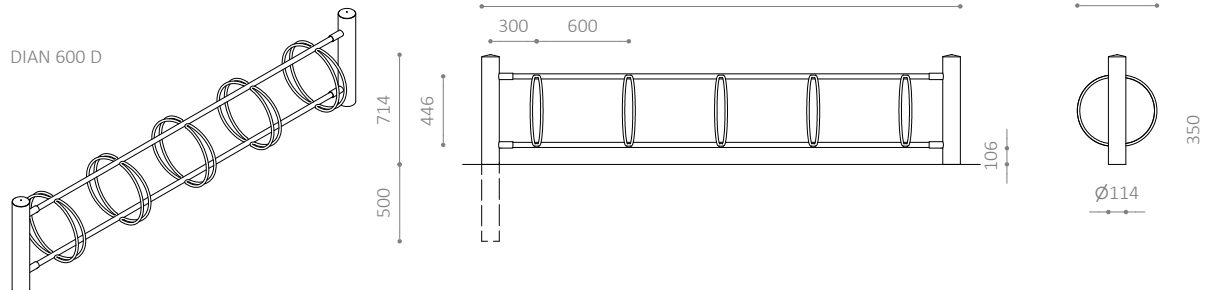

DIAN 600 DS

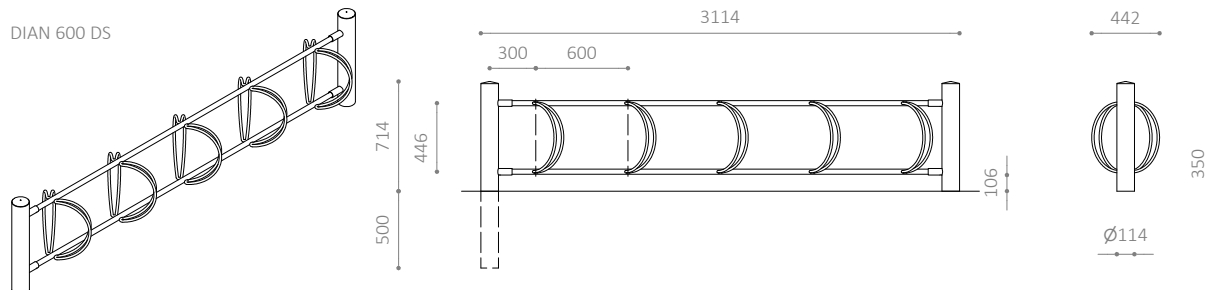

## DIAN CC600 BIKE RACK

- Bike rack with extra distance between clamps (c/c 600mm)
- Single or double-sided bike rack
- Angled clamps that suit all types of tyre
- Allows room for lights on front wheel fork
- Modular, so can be assembled in the length required
- Available vertical (90°) or angled (45°)
- Also available as an individual stand (Snap or wall)
- Also available in any RAL colour

## MATERIALS:

- Hot-dip galvanised steel
- Also available in powder-coated, hot-dip galvanised steel

## DIMENSIONS:

- Columns, DIAN: Ø114 mm
- Columns, Snap: Ø42 mm
- Bars: Ø33 mm
- Clamps: Ø16 mm
- Distance between clamps: c/c 600 mm (also available: c/c 500 mm)

## MODULE SIZES:

- Single-sided: 3, 4, 5 or 6 parking spots
- Double-sided: 6, 8 or 10 parking spots

## INSTALLATION:

- Available for embedding or bolting to the foundation or wall mounting
- Recommended base dimensions: Ø300 x H:600 mm
- Distance from ground to middle of clamp: 250 mm
- Distance from ground to lower edge of clamp: 110 mm

DIAN 600 V

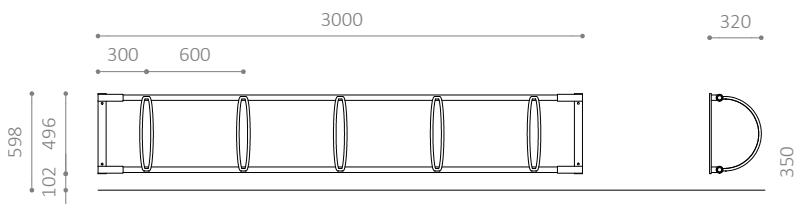
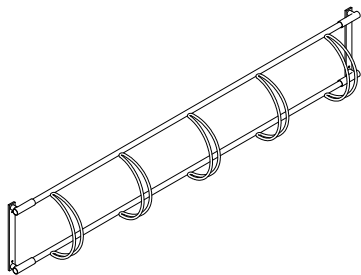

DIAN 600 VS

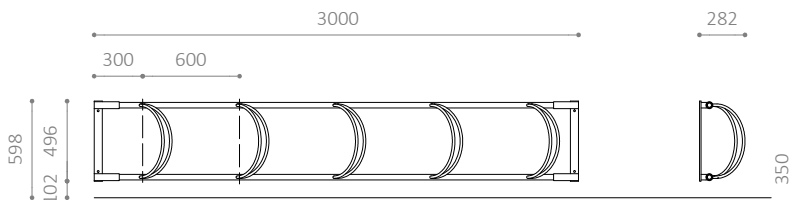
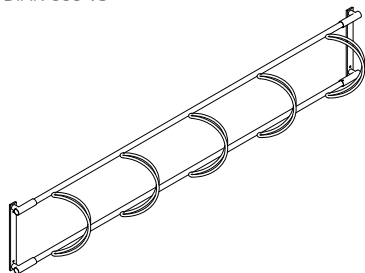

DIAN VE

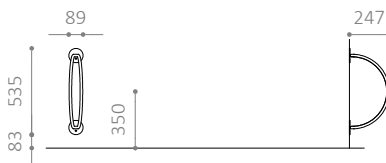

DIAN VS

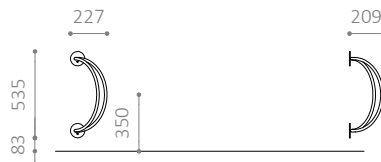

## DIAN CC600 BIKE RACK

- Bike rack with extra distance between clamps (c/c 600mm)
- Single or double-sided bike rack
- Angled clamps that suit all types of tyre
- Allows room for lights on front wheel fork
- Modular, so can be assembled in the length required
- Available vertical (90°) or angled (45°)
- Also available as an individual stand (Snap or wall)
- Also available in any RAL colour

## MATERIALS:

- Hot-dip galvanised steel
- Also available in powder-coated, hot-dip galvanised steel

## DIMENSIONS:

- Columns, DIAN: Ø114 mm
- Columns, Snap: Ø42 mm
- Bars: Ø33 mm
- Clamps: Ø16 mm
- Distance between clamps: c/c 600 mm (also available: c/c 500 mm)

## MODULE SIZES:

- Single-sided: 3, 4, 5 or 6 parking spots
- Double-sided: 6, 8 or 10 parking spots

## INSTALLATION:

- Available for embedding or bolting to the foundation or wall mounting
- Recommended base dimensions: Ø300 x H:600 mm
- Distance from ground to middle of clamp: 250 mm
- Distance from ground to lower edge of clamp: 110 mm