



C05 CC600 BIKE RACK

Design: HITSA

Bike rack with extra distance between clamps (c/c 600 mm)
Modular, so can be assembled in the length required
Available vertical (90°) or angled (45°)



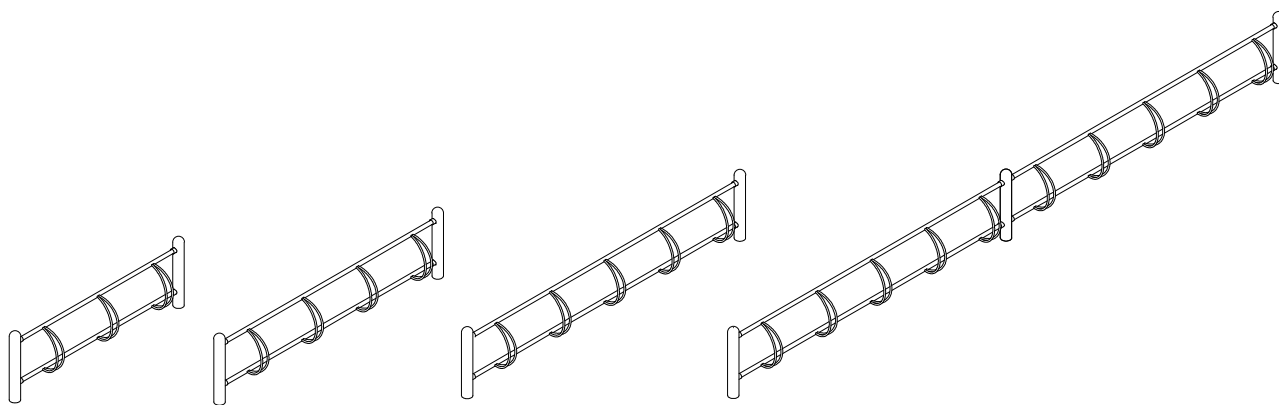

CO5 600

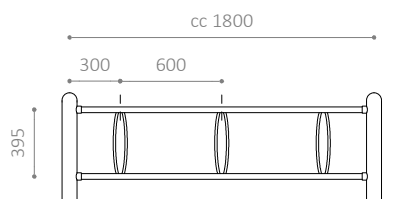

CO5 600

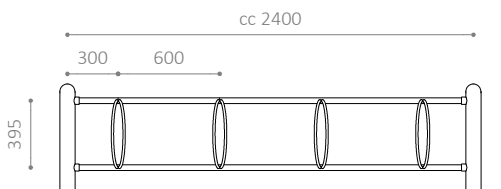

CO5 600

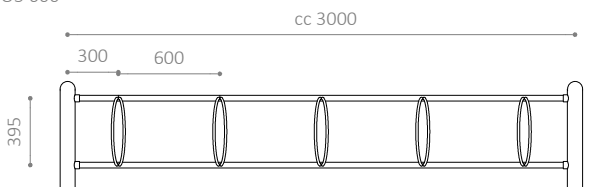

CO5 CC600 BIKE RACK

- Bike rack with extra distance between clamps (c/c 600 mm)
- Angled clamps that suit all types of tyre
- Allows room for lights attached to the front wheel
- Modular, so can be assembled in the length required
- Single- or double-sided
- Available vertical (90°) or angled (45°)
- Also available as an individual stand (Snap or wall)
- Also available in any RAL colour

MATERIALS:

- Hot-dip galvanised steel
- Also available in powder-coated, hot-dip galvanised steel

DIMENSIONS:

- Columns: Ø89 mm
- Bars: Ø35 mm
- Clamps: Ø14 mm
- Standard distance between clamps: c/c 600 mm
- Also available: c/c 500 mm

MODULE SIZES:

- Single-sided: 3, 4 or 5 parking spots
- Double-sided: 6, 8 or 10 parking spots

INSTALLATION:

- Available for embedding or bolting to the foundation or wall mounting
- Recommended base dimensions: Ø300 x H600 mm
- Distance from ground to middle of clamp: 350 mm
- Distance from ground to lower edge of clamp: 130 mm

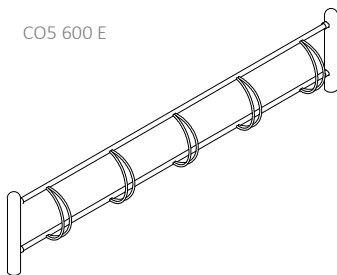

CO5 600 E

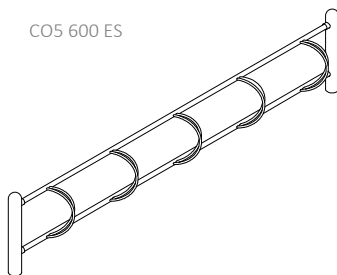
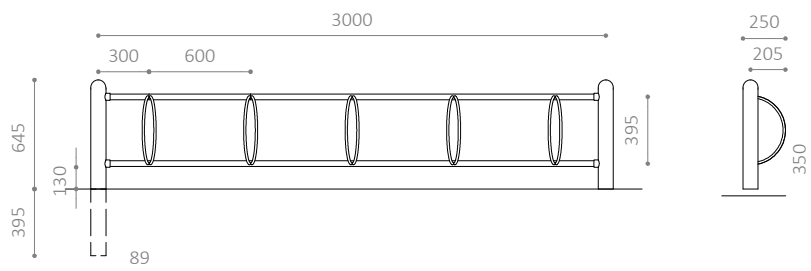

CO5 600 ES

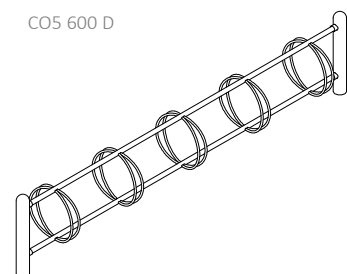
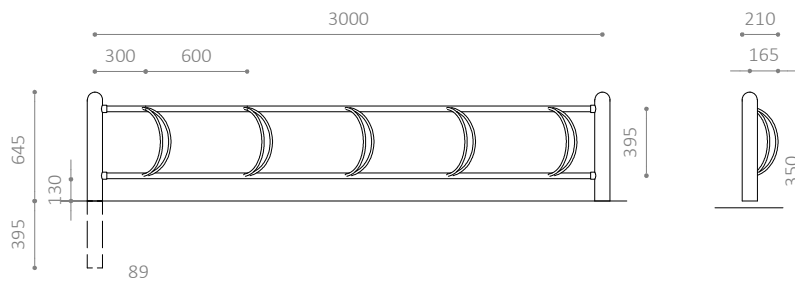

CO5 600 D

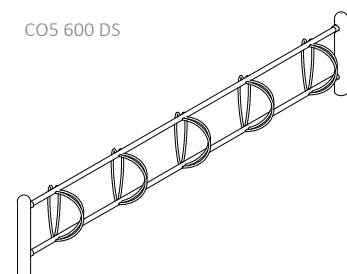
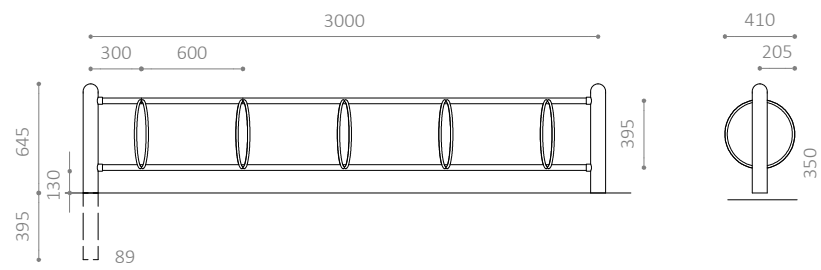

CO5 600 DS

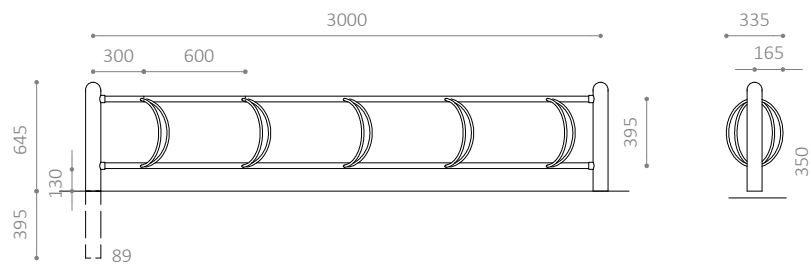

CO5 CC600 BIKE RACK

- Bike rack with extra distance between clamps (c/c 600 mm)
- Angled clamps that suit all types of tyre
- Allows room for lights attached to the front wheel
- Modular, so can be assembled in the length required
- Single- or double-sided
- Available vertical (90°) or angled (45°)
- Also available as an individual stand (Snap or wall)
- Also available in any RAL colour

MATERIALS:

- Hot-dip galvanised steel
- Also available in powder-coated, hot-dip galvanised steel

DIMENSIONS:

- Columns: Ø89 mm
- Bars: Ø35 mm
- Clamps: Ø14 mm
- Standard distance between clamps: c/c 600 mm
- Also available: c/c 500 mm

MODULE SIZES:

- Single-sided: 3, 4 or 5 parking spots
- Double-sided: 6, 8 or 10 parking spots

INSTALLATION:

- Available for embedding or bolting to the foundation or wall mounting
- Recommended base dimensions: Ø300 x H600 mm
- Distance from ground to middle of clamp: 350 mm
- Distance from ground to lower edge of clamp: 130 mm

CO5 600 V

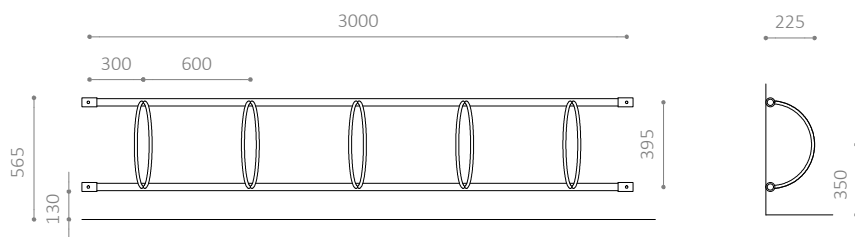
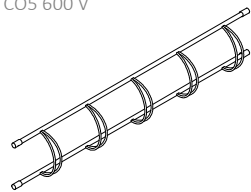

CO5 600 VS

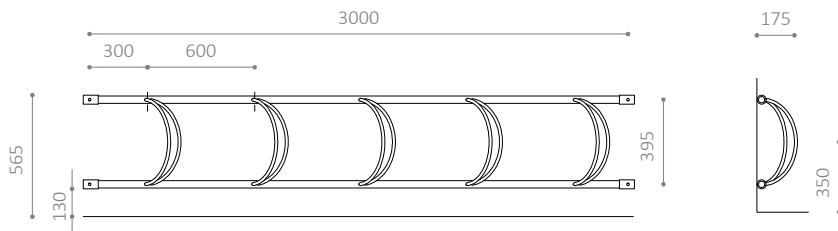
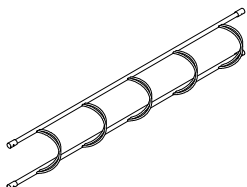

CO5 SnapE

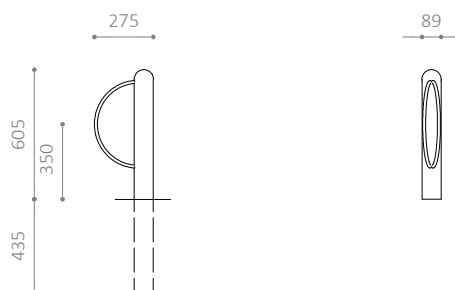
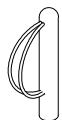

CO5 SnapD

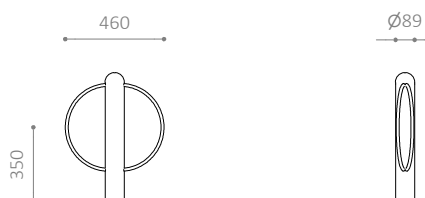
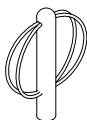

CO5 CC600 BIKE RACK

- Bike rack with extra distance between clamps (c/c 600 mm)
- Angled clamps that suit all types of tyre
- Allows room for lights attached to the front wheel
- Modular, so can be assembled in the length required
- Single- or double-sided
- Available vertical (90°) or angled (45°)
- Also available as an individual stand (Snap or wall)
- Also available in any RAL colour

MATERIALS:

- Hot-dip galvanised steel
- Also available in powder-coated, hot-dip galvanised steel

DIMENSIONS:

- Columns: Ø89 mm
- Bars: Ø35 mm
- Clamps: Ø14 mm
- Standard distance between clamps: c/c 600 mm
- Also available: c/c 500 mm

MODULE SIZES:

- Single-sided: 3, 4 or 5 parking spots
- Double-sided: 6, 8 or 10 parking spots

INSTALLATION:

- Available for embedding or bolting to the foundation or wall mounting
- Recommended base dimensions: Ø300 x H600 mm
- Distance from ground to middle of clamp: 350 mm
- Distance from ground to lower edge of clamp: 130 mm