



FJORDPARK CAFÉ TABLE SET

Design: VE2

Round bistro table with 1-4 chairs

The table is also available as a steel side table

The chair can be placed anywhere around the table or can stand alone



Fjordpark ST Z N/ AN

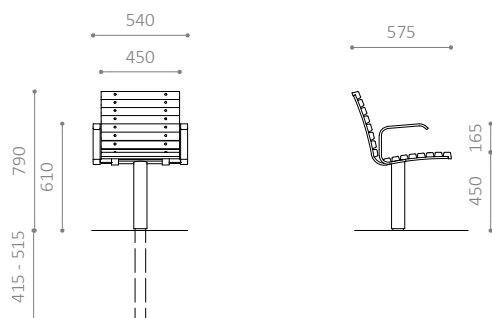
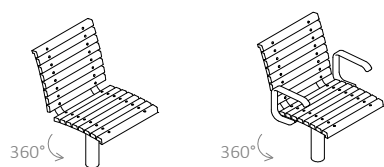

Fjordpark ST ZF / ZAF

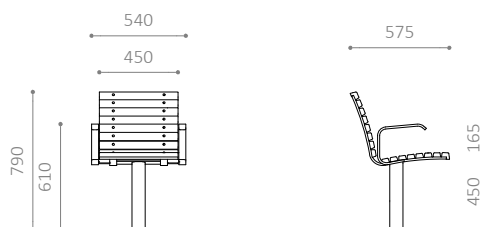
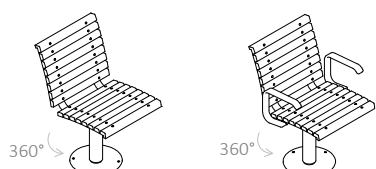

Fjordpark ST N/ NA

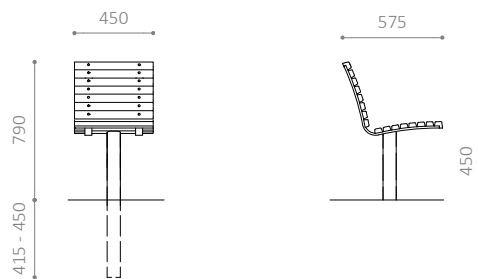
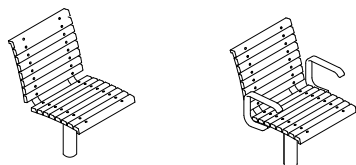

Fjordpark ST F / FA

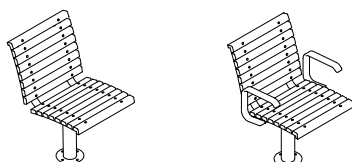

FJORDPARK CAFÉ TABLE SET

- Round bistro table with freely placed chairs
- Chairs can be used alone or with a table
- Chairs also available with swivel base or armrests
- Bistro table: Ø760 mm, hot-dip galvanised steel and slats
- Side table/high table: Ø460 mm, hot-dip galvanised steel
- Also available in any RAL colour

MATERIALS:

- Oil-treated, FSC®-certified mahogany
- Also available in untreated FSC®-certified mahogany
- Hot-dip galvanised steel
- Also available in powder-coated, hot-dip galvanised steel

DIMENSIONS:

- Columns: Ø76 mm
- Frame: 690 x 120 mm flattened steel
- Seat brackets: 40 x 12 mm flattened steel
- Slats, chair: 23/36 x 40/44 mm
- Slats table: 23 x 45 mm

INSTALLATION:

- Available for embedding or bolting to the foundation
- Recommended base dimensions: Ø300 x H600 mm
- Recommended seating height, front edge (above the column): 400 mm
- Recommended height at front edge: 440 mm
- Recommended table height: 700-720 mm



The mark of responsible forestry

Fjordpark BO Ø460 N/F

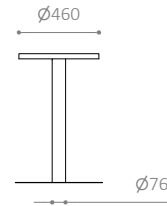
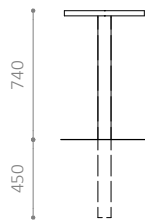
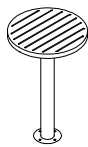
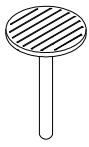

Fjordpark BO Ø760 N/F

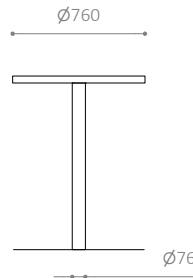
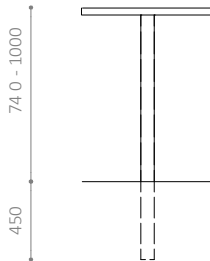
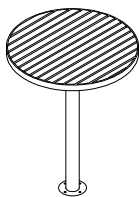
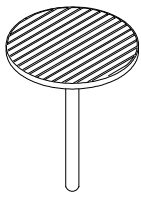

FJORDPARK CAFÉ TABLE SET

- Round bistro table with freely placed chairs
- Chairs can be used alone or with a table
- Chairs also available with swivel base or armrests
- Bistro table: Ø760 mm, hot-dip galvanised steel and slats
- Side table/high table: Ø460 mm, hot-dip galvanised steel
- Also available in any RAL colour

MATERIALS:

- Oil-treated, FSC®-certified mahogany
- Also available in untreated FSC®-certified mahogany
- Hot-dip galvanised steel
- Also available in powder-coated, hot-dip galvanised steel

DIMENSIONS:

- Columns: Ø76 mm
- Frame: 690 x 120 mm flattened steel
- Seat brackets: 40 x 12 mm flattened steel
- Slats, chair: 23/36 x 40/44 mm
- Slats table: 23 x 45 mm

INSTALLATION:

- Available for embedding or bolting to the foundation
- Recommended base dimensions: Ø300 x H600 mm
- Recommended seating height, front edge (above the column): 400 mm
- Recommended height at front edge: 440 mm
- Recommended table height: 700-720 mm



The mark of responsible forestry