



## NORD PARK BENCH

Design: C.F. MØLLER DESIGN

Series with park bench, chair and table

Modules can also be assembled in a straight line or at an angle using a corner module (45°)

Optional extra: Armrests

Also available in any RAL colour



Nord BN

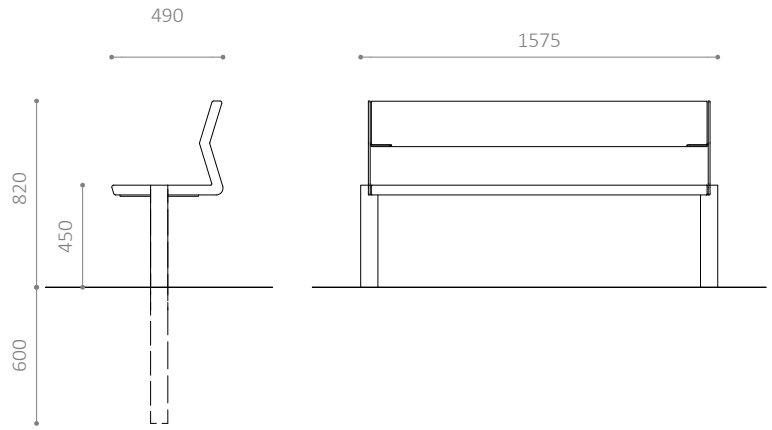
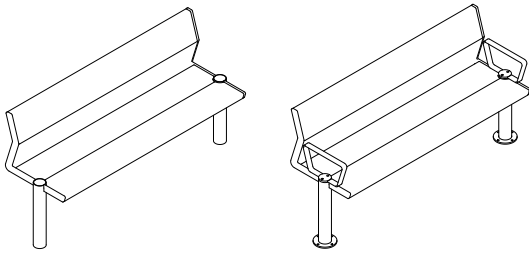

Nord PL

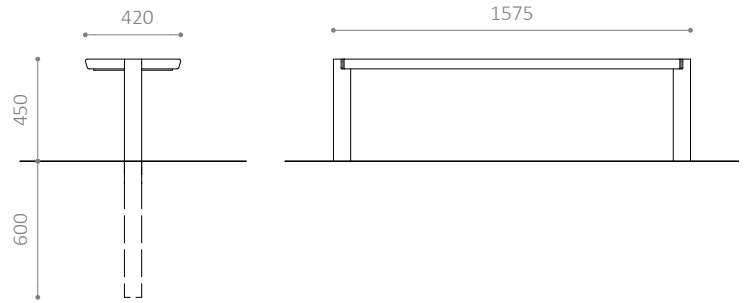
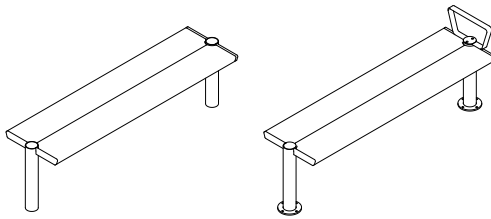

Nord BO

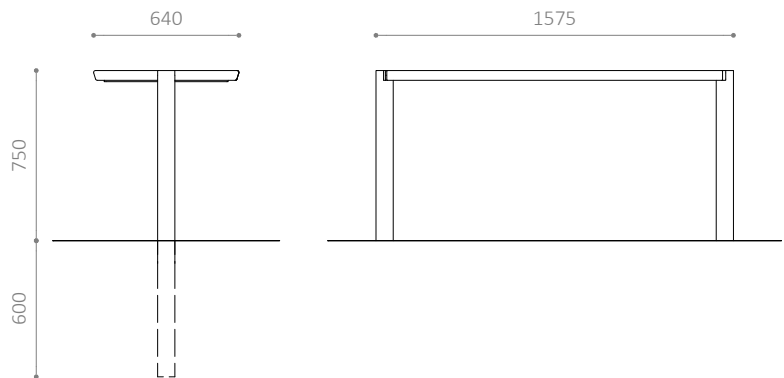
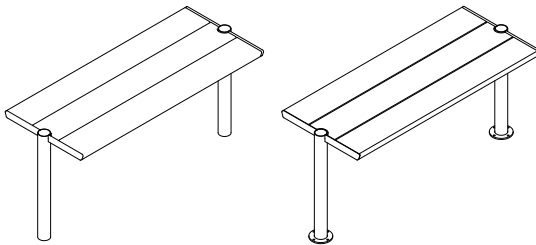

**NORD SERIES**

- Series with park bench, chair and table
- Modules can be assembled in a straight line
- Modules can also be assembled at an angle using a corner module (45°)
- Optional extra: Armrests
- Also available in any RAL colour

**MATERIALS:**

- Sature or oil-treated FSC®-certified mahogany
- Also available in untreated FSC®-certified mahogany
- Hot-dip galvanised steel
- Also available in powder-coated, hot-dip galvanised steel

**DIMENSIONS:**

Frame: 43 x 8 mm flattened steel

Legs: Ø76 mm steel tube

Slats: 207 x 43 mm

**INSTALLATION:**

- Available for embedding or bolting to the ground
- Recommended base dimensions: Ø400 x H600 mm
- Seating height: 450 mm



The mark of responsible forestry

Nord ST

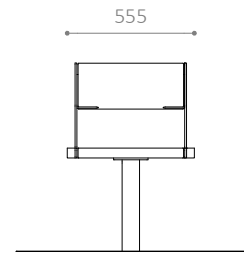
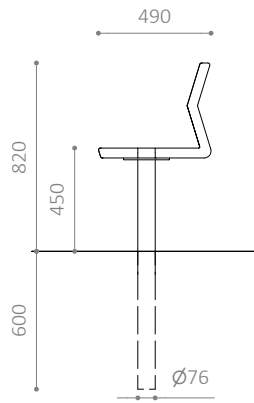
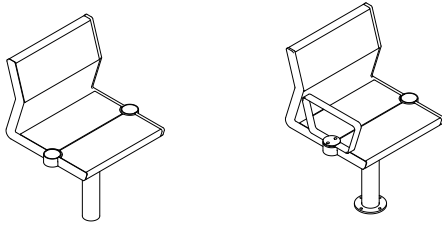

Nord STZ

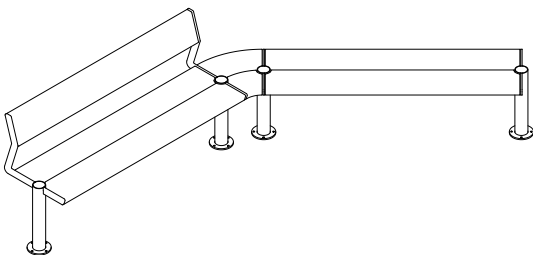
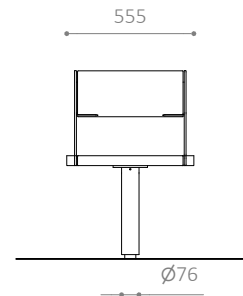
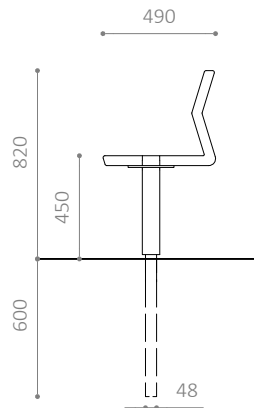
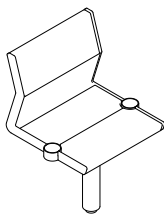

**NORD SERIES**

- Series with park bench, chair and table
- Modules can be assembled in a straight line
- Modules can also be assembled at an angle using a corner module (45°)
- Optional extra: Armrests
- Also available in any RAL colour

**MATERIALS:**

- Sature or oil-treated FSC®-certified mahogany
- Also available in untreated FSC®-certified mahogany
- Hot-dip galvanised steel
- Also available in powder-coated, hot-dip galvanised steel

**DIMENSIONS:**

Frame: 43 x 8 mm flattened steel

Legs: Ø76 mm steel tube

Slats: 207 x 43 mm

**INSTALLATION:**

- Available for embedding or bolting to the ground
- Recommended base dimensions: Ø400 x H600 mm
- Seating height: 450 mm



The mark of responsible forestry

Nord A

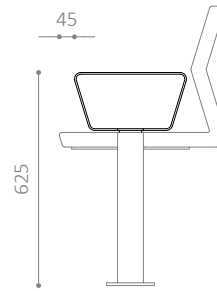
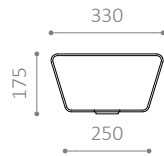
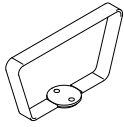

Nord A PL XL

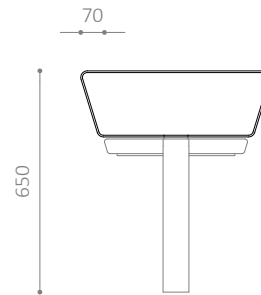
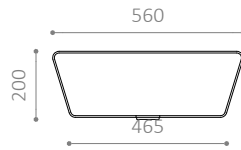
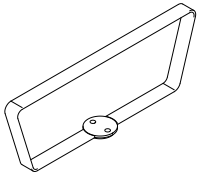

Nord A BN XL

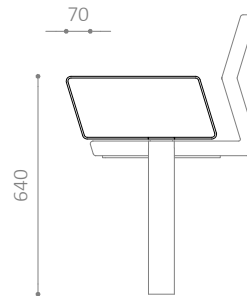
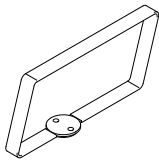

#### NORD SERIES

- Series with park bench, chair and table
- Modules can be assembled in a straight line
- Modules can also be assembled at an angle using a corner module (45°)
- Optional extra: Armrests
- Also available in any RAL colour

#### MATERIALS:

- Sature or oil-treated FSC®-certified mahogany
- Also available in untreated FSC®-certified mahogany
- Hot-dip galvanised steel
- Also available in powder-coated, hot-dip galvanised steel

#### DIMENSIONS:

Frame: 43 x 8 mm flattened steel

Legs: Ø76 mm steel tube

Slats: 207 x 43 mm

#### INSTALLATION:

- Available for embedding or bolting to the ground
- Recommended base dimensions: Ø400 x H600 mm
- Seating height: 450 mm



The mark of responsible forestry