



ADD PLUS MODULAR PARK BENCH

Design: BYMUNCH BY- OG LANDSKABSDESIGN

Series of park bench modules which can be combined as needed
Also available as seating for things such as concrete benches
Also available in any RAL colour



ADD Plus O F

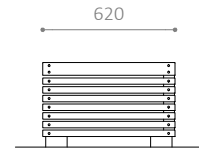
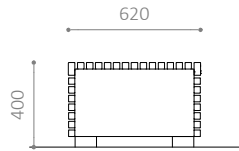
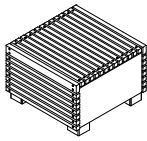

ADD Plus O N

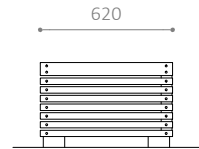
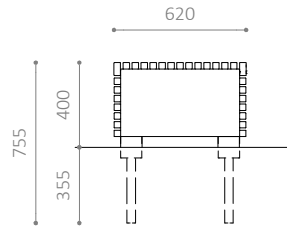
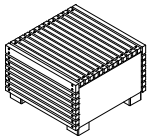

ADD Plus S F

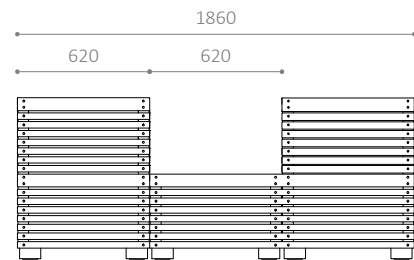
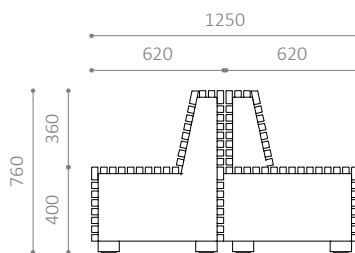
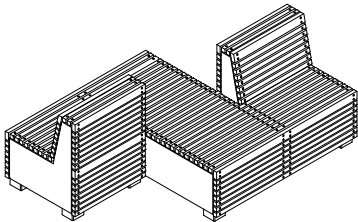

ADD Plus S N

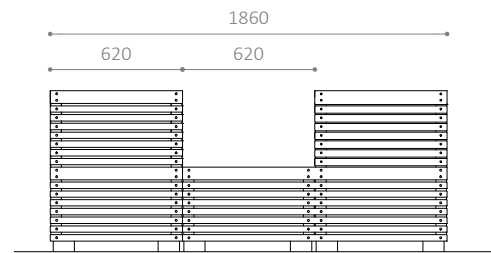
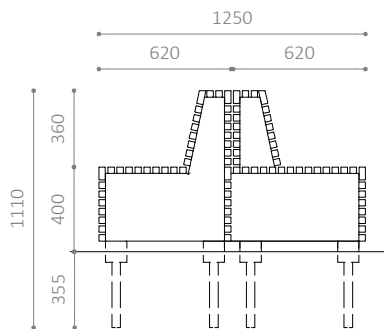
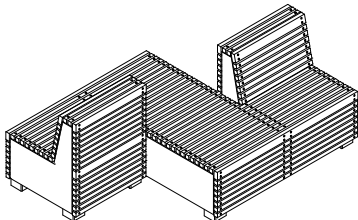

ADD PLUS MODULAR PARK BENCH

- Series of park bench modules which can be combined as needed
- Also available as seating for things such as concrete benches
- Also available in any RAL colour

MATERIALS:

- Gables in stainless steel
- Oil-treated, FSC®-certified mahogany
- Also available in untreated FSC®-certified mahogany
- Hot-dip galvanised steel
- Also available in powder-coated, hot-dip galvanised steel

DIMENSIONS:

- Gables: 4 mm stainless steel
- Legs: 100 x 100 mm square steel tube
- Edging slats: 60 x 30 mm
- Centre slats: 30 x 30 mm

INSTALLATION:

- Supplied for embedment
- Recommended base dimensions: Ø250 x H400 mm
- Recommended seat height: 390 mm



The mark of responsible forestry

ADD Plus T F

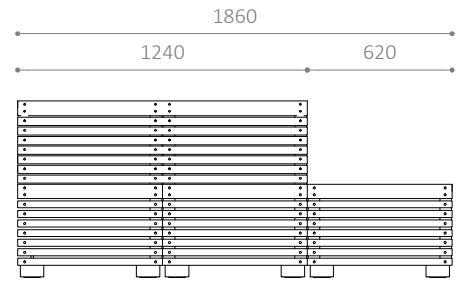
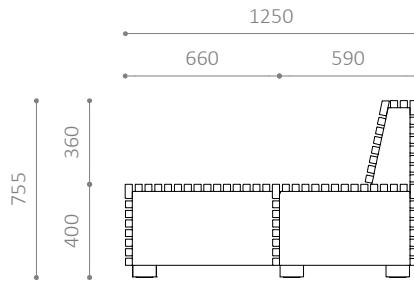
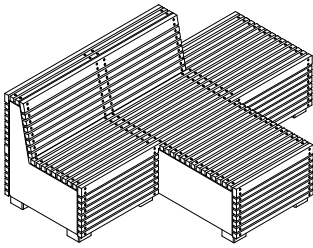

ADD Plus T N

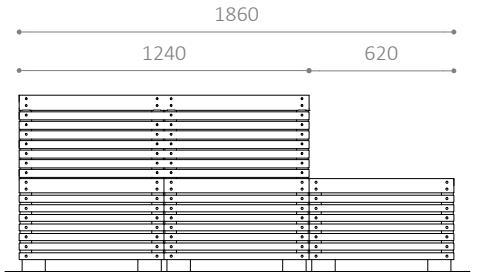
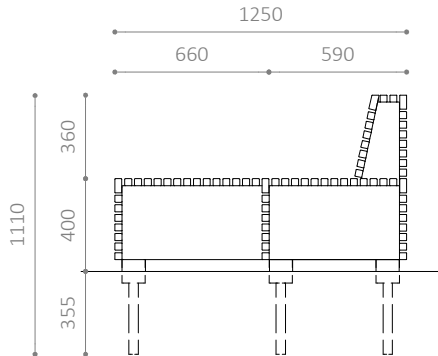
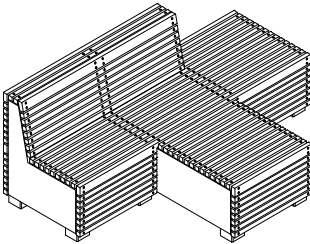

ADD Plus T IF

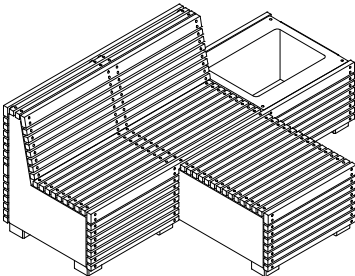

ADD PLUS MODULAR PARK BENCH

- Series of park bench modules which can be combined as needed
- Also available as seating for things such as concrete benches
- Also available in any RAL colour

MATERIALS:

- Gables in stainless steel
- Oil-treated, FSC®-certified mahogany
- Also available in untreated FSC®-certified mahogany
- Hot-dip galvanised steel
- Also available in powder-coated, hot-dip galvanised steel

DIMENSIONS:

- Gables: 4 mm stainless steel
- Legs: 100 x 100 mm square steel tube
- Edging slats: 60 x 30 mm
- Centre slats: 30 x 30 mm

INSTALLATION:

- Supplied for embedment
- Recommended base dimensions: Ø250 x H400 mm
- Recommended seat height: 390 mm



The mark of responsible forestry

ADD Plus O IF

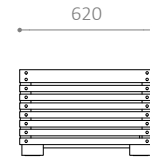
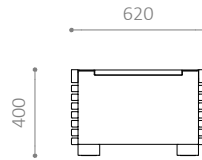
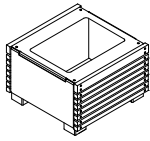

ADD Plus O IN

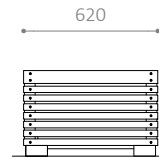
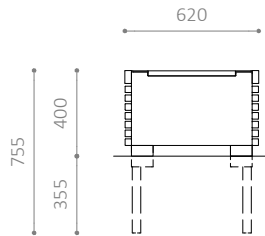
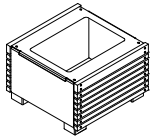

ADD Plus BN B

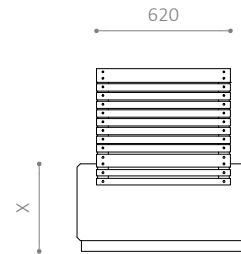
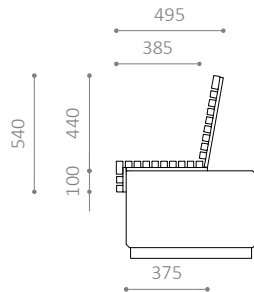
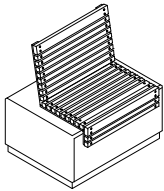

ADD Plus PL B

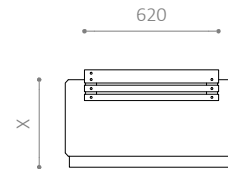
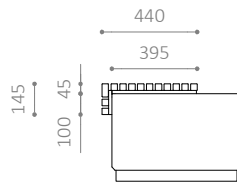
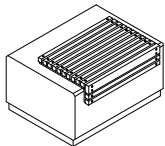

ADD PLUS MODULAR PARK BENCH

- Series of park bench modules which can be combined as needed
- Also available as seating for things such as concrete benches
- Also available in any RAL colour

MATERIALS:

- Gables in stainless steel
- Oil-treated, FSC®-certified mahogany
- Also available in untreated FSC®-certified mahogany
- Hot-dip galvanised steel
- Also available in powder-coated, hot-dip galvanised steel

DIMENSIONS:

- Gables: 4 mm stainless steel
- Legs: 100 x 100 mm square steel tube
- Edging slats: 60 x 30 mm
- Centre slats: 30 x 30 mm

INSTALLATION:

- Supplied for embedment
- Recommended base dimensions: Ø250 x H400 mm
- Recommended seat height: 390 mm



The mark of responsible forestry